



GIA®

GIA REPORT 1226872999

Verify this report at GIA.edu

GIA NATURAL COLORED DIAMOND REPORT

March 23, 2023

Report Type **Grading Report**

GIA Report Number **1226872999**

Shape and Cutting Style **Oval Brilliant**

Measurements **13.61 x 11.36 x 6.67 mm**

Carat Weight **6.57 carat**

Color Grade **Fancy Intense Yellow**

Color Origin **Natural**

Color Distribution **Even**

Clarity Grade **VVS1**

Proportions:

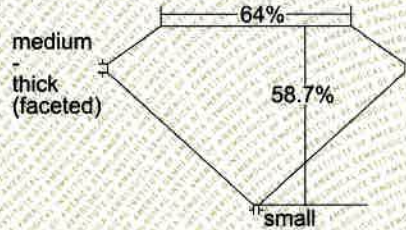

Profile not to actual proportions

Polish **Good**

Symmetry **Good**

Fluorescence **None**

ADDITIONAL INFORMATION

GIA COLORED DIAMOND SCALE

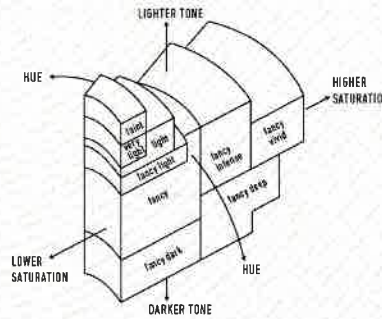
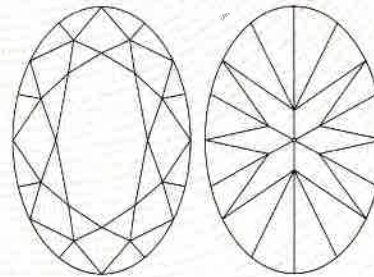

Illustration of GIA fancy color grade interrelationships

GIA CLARITY SCALE

FLAWLESS
INTERNALLY FLAWLESS
VERY VERY SLIGHTLY INCLUDED
VVS ₁
VVS ₂
VERY SLIGHTLY INCLUDED
VS ₁
VS ₂
SLIGHTLY INCLUDED
S _{I1}
S _{I2}
I ₁
I ₂
I ₃
INCLUDED

CLARITY CHARACTERISTICS



KEY TO SYMBOLS*

- ~ Feather
- ▲ Chip

* Red symbols denote internal characteristics (inclusions). Green or black symbols denote external characteristics (blemishes). Diagram is an approximate representation of the diamond, and symbols shown indicate type, position, and approximate size of clarity characteristics. All clarity characteristics may not be shown. Details of finish are not shown.



reportcheck.gia.edu



The results documented in this report refer only to the diamond described, and were obtained using the techniques and equipment available to GIA at the time of examination. This report is not a guarantee or valuation. For additional information and important limitations and disclaimers, please see GIA.edu/terms or call +1 800 421 7250 or +1 760 603 4500. ©2022 Gemological Institute of America, Inc.

THE SECURITY FEATURES IN THIS DOCUMENT, INCLUDING THE Hologram, SECURITY SCREEN AND MICROPRINT LINES, IN ADDITION TO THOSE NOT LISTED, EXCEED DOCUMENT SECURITY INDUSTRY GUIDELINES

Verify this report at GIA.edu

GIA NATURAL COLORED DIAMOND REPORT

March 23, 2023

Report Type **Grading Report**

GIA Report Number **2221873001**

Shape and Cutting Style **Oval Brilliant**

Measurements **13.29 x 10.90 x 7.01 mm**

Carat Weight **6.56 carat**

Color Grade **Fancy Intense Yellow**

Color Origin **Natural**

Color Distribution **Even**

Clarity Grade **VS1**

Proportions:

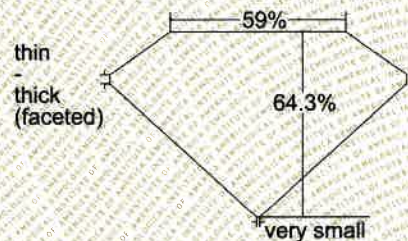

Profile not to actual proportions

Polish **Good**

Symmetry **Good**

Fluorescence **None**

Comments: Additional clouds are not shown.

ADDITIONAL INFORMATION

GIA COLORED DIAMOND SCALE

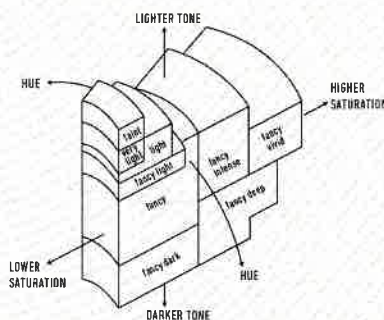
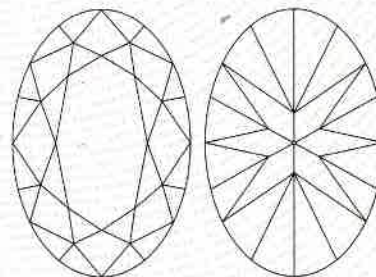

Illustration of GIA fancy color grade interrelationships

GIA CLARITY SCALE

FLAWLESS
INTERNALLY FLAWLESS
VVS ₁
VVS ₂
VS ₁
VS ₂
S ₁
S ₂
I ₁
I ₂
I ₃

CLARITY CHARACTERISTICS



KEY TO SYMBOLS*

Cloud

Pinpoint

* Red symbols denote internal characteristics (inclusions). Green or black symbols denote external characteristics (blemishes). Diagram is an approximate representation of the diamond, and symbols shown indicate type, position, and approximate size of clarity characteristics. All clarity characteristics may not be shown. Details of finish are not shown.



reportcheck.gia.edu



The results documented in this report refer only to the diamond described, and were obtained using the techniques and equipment available to GIA at the time of examination. This report is not a guarantee or valuation. For additional information and important limitations and disclaimers, please see GIA.edu/terms or call +1 800 421 7250 or +1 760 603 4500. ©2022 Gemological Institute of America, Inc.



GIA®

GIA REPORT 2225872979

Verify this report at GIA.edu

GIA NATURAL COLORED DIAMOND REPORT

March 27, 2023

Report Type Grading Report

GIA Report Number 2225872979

Shape and Cutting Style Oval Brilliant

Measurements 16.82 x 13.66 x 8.46 mm

Carat Weight 12.41 carat

Color Grade Fancy Intense Yellow

Color Origin Natural

Color Distribution Even

Clarity Grade VVS2

Proportions:

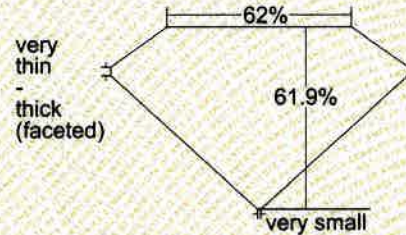

Profile not to actual proportions

Polish Good

Symmetry Good

Fluorescence None

ADDITIONAL INFORMATION

GIA COLORED DIAMOND SCALE

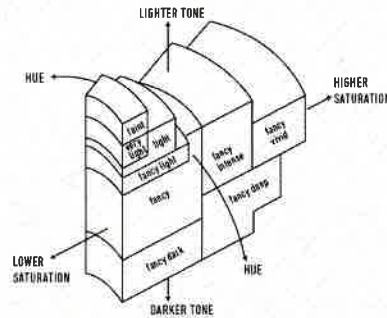
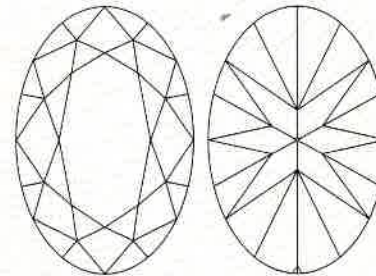

Illustration of GIA fancy color grade interrelationships

GIA CLARITY SCALE

FLAWLESS
INTERNALLY FLAWLESS
VVS ₁
VVS ₂
VS ₁
VS ₂
SI ₁
SI ₂
I ₁
I ₂
I ₃

CLARITY CHARACTERISTICS



KEY TO SYMBOLS*

- Cloud
- △ Extra Facet

* Red symbols denote internal characteristics (inclusions). Green or black symbols denote external characteristics (blemishes). Diagram is an approximate representation of the diamond, and symbols shown indicate type, position, and approximate size of clarity characteristics. All clarity characteristics may not be shown. Details of finish are not shown.



reportcheck.gia.edu



The results documented in this report refer only to the diamond described, and were obtained using the techniques and equipment available to GIA at the time of examination. This report is not a guarantee or valuation. For additional information and important limitations and disclaimers, please see GIA.edu/terms or call +1 800 421 7250 or +1 760 603 4500. ©2022 Gemological Institute of America, Inc.

THE SECURITY FEATURES IN THIS DOCUMENT, INCLUDING THE HOLOGRAM, SECURITY SCREEN AND MICROPRINT LINES, IN ADDITION TO THOSE NOT LISTED, EXCEED DOCUMENT SECURITY INDUSTRY GUIDELINES

GIA NATURAL COLORED DIAMOND REPORT

March 23, 2023
 Report Type Grading Report
 GIA Report Number 2225872982
 Shape and Cutting Style Oval Brilliant
 Measurements 12.26 x 10.04 x 6.18 mm
 Carat Weight 4.85 carat
 Color Grade Fancy Intense Yellow
 Color Origin Natural
 Color Distribution Even
 Clarity Grade VVS1
 Proportions:

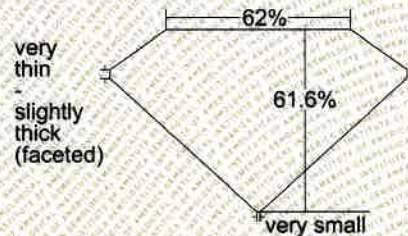

Profile not to actual proportions

Polish Good
 Symmetry Very Good
 Fluorescence None

ADDITIONAL INFORMATION

GIA COLORED DIAMOND SCALE

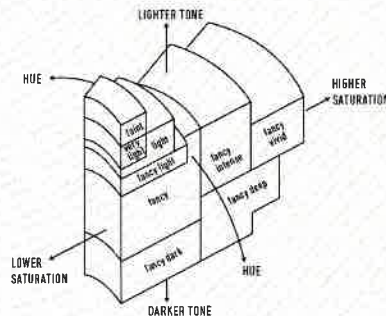
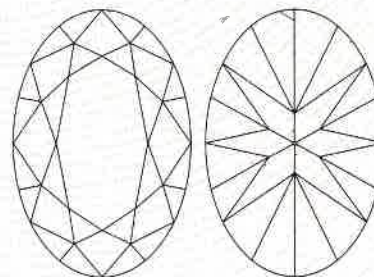

Illustration of GIA fancy color grade interrelationships

GIA CLARITY SCALE

FLAWLESS
INTERNALLY FLAWLESS
VVS ₁
VVS ₂
VS ₁
VS ₂
S _{I1}
S _{I2}
I ₁
I ₂
I ₃

CLARITY CHARACTERISTICS



KEY TO SYMBOLS*

- Cavity
- ~ Feather
- ▲ Chip
- △ Extra Facet

* Red symbols denote internal characteristics (inclusions). Green or black symbols denote external characteristics (blemishes). Diagram is an approximate representation of the diamond, and symbols shown indicate type, position, and approximate size of clarity characteristics. All clarity characteristics may not be shown. Details of finish are not shown.



reportcheck.gia.edu



The results documented in this report refer only to the diamond described, and were obtained using the techniques and equipment available to GIA at the time of examination. This report is not a guarantee or valuation. For additional information and important limitations and disclaimers, please see GIA.edu/terms or call +1 800 421 7250 or +1 760 603 4500. ©2022 Gemological Institute of America, Inc.



GIA®

GIA REPORT 2225872985

Verify this report at GIA.edu

GIA NATURAL COLORED DIAMOND REPORT

March 27, 2023

Report Type Grading Report

GIA Report Number 2225872985

Shape and Cutting Style Oval Brilliant

Measurements 12.10 x 10.02 x 6.24 mm

Carat Weight 4.83 carat

Color Grade Fancy Intense Yellow

Color Origin Natural

Color Distribution Even

Clarity Grade VVS2

Proportions:

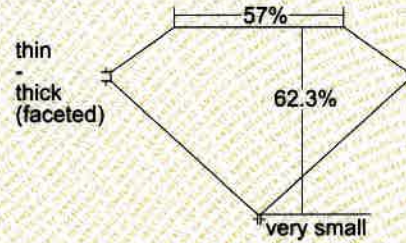

Profile not to actual proportions

Polish Good

Symmetry Good

Fluorescence None

ADDITIONAL INFORMATION

GIA COLORED DIAMOND SCALE

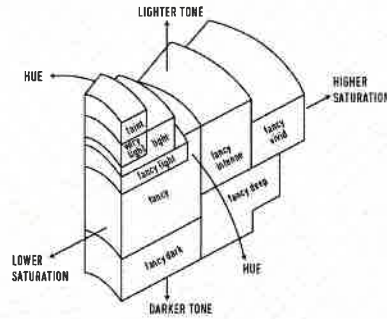
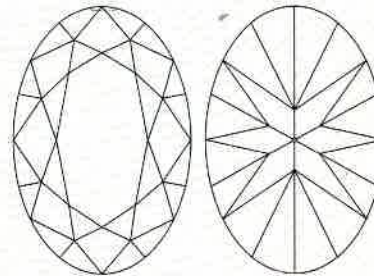

Illustration of GIA fancy color grade interrelationships

GIA CLARITY SCALE

FLAWLESS
INTERNALLY FLAWLESS
VVS ₁
VVS ₂
VS ₁
VS ₂
S _{I1}
S _{I2}
I ₁
I ₂
I ₃

CLARITY CHARACTERISTICS



KEY TO SYMBOLS*

- ~ Feather
- Pinpoint
- ^ Natural

* Red symbols denote internal characteristics (inclusions). Green or black symbols denote external characteristics (blemishes). Diagram is an approximate representation of the diamond, and symbols shown indicate type, position, and approximate size of clarity characteristics. All clarity characteristics may not be shown. Details of finish are not shown.



reportcheck.gia.edu



The results documented in this report refer only to the diamond described, and were obtained using the techniques and equipment available to GIA at the time of examination. This report is not a guarantee or valuation. For additional information and important limitations and disclaimers, please see GIA.edu/terms or call +1 800 421 7250 or +1 760 603 4500. ©2022 Gemological Institute of America, Inc.

THE SECURITY FEATURES IN THIS DOCUMENT, INCLUDING THE HOLOGRAM, SECURITY SCREEN AND MICROPRINT LINES, IN ADDITION TO THOSE NOT LISTED, EXCEED DOCUMENT SECURITY INDUSTRY GUIDELINES



GIA®

GIA REPORT 6224872981

Verify this report at GIA.edu

GIA NATURAL COLORED DIAMOND REPORT

March 29, 2023

Report Type **Grading Report**

GIA Report Number **6224872981**

Shape and Cutting Style **Oval Brilliant**

Measurements **13.22 x 10.63 x 6.60 mm**

Carat Weight **6.05 carat**

Color Grade **Fancy Intense Yellow**

Color Origin **Natural**

Color Distribution **Even**

Clarity Grade **VVS1**

Proportions:

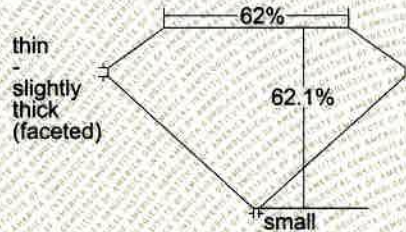

Profile not to actual proportions

Polish **Good**

Symmetry **Good**

Fluorescence **None**

ADDITIONAL INFORMATION

GIA COLORED
DIAMOND
SCALE

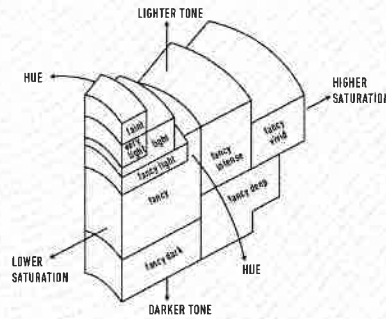
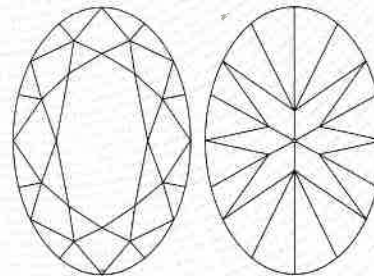

Illustration of GIA fancy color grade interrelationships

GIA
CLARITY
SCALE

FLAWLESS
INTERNALLY FLAWLESS
VVS ₁
VVS ₂
VS ₁
VS ₂
S ₁
S ₂
I ₁
I ₂
I ₃

CLARITY CHARACTERISTICS



KEY TO SYMBOLS*

- ~ Feather
- ^ Extra Facet

* Red symbols denote internal characteristics (inclusions). Green or black symbols denote external characteristics (blemishes). Diagram is an approximate representation of the diamond, and symbols shown indicate type, position, and approximate size of clarity characteristics. All clarity characteristics may not be shown. Details of finish are not shown.



reportcheck.gia.edu



The results documented in this report refer only to the diamond described, and were obtained using the techniques and equipment available to GIA at the time of examination. This report is not a guarantee or valuation. For additional information and important limitations and disclaimers, please see GIA.edu/terms or call +1 800 421 7250 or +1 760 603 4500. ©2022 Gemological Institute of America, Inc.



THE SECURITY FEATURES IN THIS DOCUMENT, INCLUDING THE HOLOGRAM, SECURITY SCREEN AND MICROPRINT LINES, IN ADDITION TO THOSE NOT LISTED, EXCEED DOCUMENT SECURITY INDUSTRY GUIDELINES

GIA NATURAL COLORED DIAMOND REPORT

March 23, 2023
 Report Type **Grading Report**
 GIA Report Number **6224873004**
 Shape and Cutting Style **Oval Brilliant**
 Measurements **13.07 x 10.39 x 6.29 mm**
 Carat Weight **5.54 carat**
 Color Grade **Fancy Intense Yellow**
 Color Origin **Natural**
 Color Distribution **Even**
 Clarity Grade **VVS1**
 Proportions:

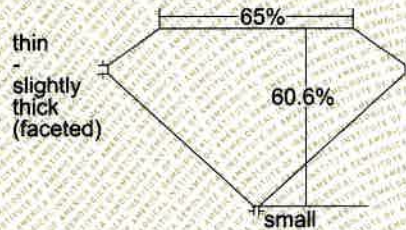

Profile not to actual proportions

Polish **Good**
 Symmetry **Very Good**
 Fluorescence **None**

ADDITIONAL INFORMATION

GIA COLORED DIAMOND SCALE

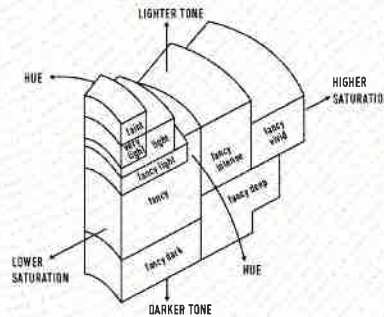
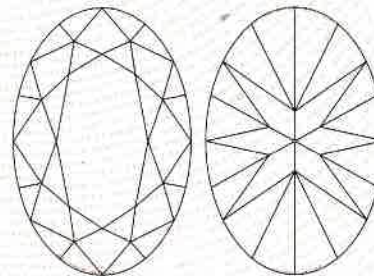

Illustration of GIA fancy color grade interrelationships

GIA CLARITY SCALE

FLAWLESS
INTERNALLY FLAWLESS
VVS ₁
VVS ₂
VS ₁
VS ₂
S ₁
S ₂
I ₁
I ₂
I ₃

CLARITY CHARACTERISTICS



KEY TO SYMBOLS*

- ☁ Cloud
- ☞ Feather
- ♠ Chip
- Bruise

* Red symbols denote internal characteristics (inclusions). Green or black symbols denote external characteristics (blemishes). Diagram is an approximate representation of the diamond, and symbols shown indicate type, position, and approximate size of clarity characteristics. All clarity characteristics may not be shown. Details of finish are not shown.



reportcheck.gia.edu



The results documented in this report refer only to the diamond described, and were obtained using the techniques and equipment available to GIA at the time of examination. This report is not a guarantee or valuation. For additional information and important limitations and disclaimers, please see GIA.edu/terms or call +1 800 421 7250 or +1 760 603 4500. ©2022 Gemological Institute of America, Inc.